

YUT-2600

**Digital Ultrasonic Flaw
Detector**

Operating Manual

Preface

Product Introduction of YUT-2600 Digital Ultrasonic Flaw Detector

Digital Ultrasonic Flaw Detector is developed by our company after scientific researches and experiments. It is identified and approved by related authoritative departments in China, such as electricity department, petrochemical department and railway departments, as a new generation of defectometer. It works on the pulse reflection fault locating principle. Its all testing functions are controlled by a micro computer. The instrument may be powered by alternative and direct current. Small size and light weight make it an ideal portable instrument. At present, it has been widely applied to nondestructive testing in the fields such as electricity, oil industry, petrochemical industry, machinery, aviation, metallurgy, boiler and pressure vessels, steel structure and armament industry etc.

The invention of YUT-2600 is a milestone of our company, which reflects our researching and developing capability has entered a new stage. Quality first, credibility first, service first and innovation first are our principles since the establishment of the company.

As a portable and small-sized testing instrument, the TFT monitor of YUT-2600 can show the testing results in most clear and pleasant way. Even in strong light, the results can be read without the help of a light shield. The comfortable soft-touch keyboard is sensitive to operations and it's water-proof and oil-proof. All keys' instructions are in Chinese. On the monitor, both English and Chinese are available.

The objectives of this instruction manual are to make users get used to the functions, performances and operations of the instrument. In order to get a quick access to the operations and functions of this instrument, and to work with it skillfully, please read this manual very carefully.

The tasks of flaws testing are very varied. So are the principles and regulations to follow. However, by using this instrument skillfully and flexibly, there will be little difficulty in completing all kinds of flaw testing missions.

Contents

CONTENTS I

CHAPTER 1 A BRIEF INTRODUCTION TO YUT-2600 1

1.1 NAMES OF THE MAJOR COMPONENTS OF THE INSTRUMENT 1

1.2 KEYPAD..... 1

1.3 DISPLAY SCREEN..... 2

1.4 BASIC OPERATION OF THE INSTRUMENT..... 2

 1.4.1 Power Supply 2

 1.4.2 Probe Connection 3

 1.4.3 Switching On and Off the Instrument 3

 1.4.4 Restore the Initial Parameters of the Instrument 3

1.5 MAIN MENU AND FUNCTIONS 4

 1.5.1 Main Menu..... 4

 1.5.2 Functional Keys 4

CHAPTER 2 FUNCTIONS, FEATURES, AND PARAMETERS OF THE INSTRUMENT..... 5

2.1 BASIC FUNCTIONS OF THE INSTRUMENT 5

2.2 FEATURES OF THE INSTRUMENT..... 5

2.3 SPECIFICATIONS 6

CHAPTER 3 DETAILED OPERATION INSTRUCTIONS 7

3.1 BASIC MENU FUNCTIONS 7

 3.1.1 Sound Path 7

 3.1.2 Sound Velocity 7

 3.1.3 Displacement..... 7

 3.1.4 Gain..... 8

 3.1.5 Compensation 8

 3.1.6 Scale..... 8

 3.1.7 Reject 9

 3.1.8 Wave Height Readings 9

3.2 SETTING MENU 9

 3.2.1 Waveform Filling 9

 3.2.2 Color Scheme 9

 3.2.3 Language..... 10

 3.2.4 Lighting..... 10

 3.2.5 Alarming 10

 3.2.6 Automatic Wave Height 10

 3.2.7 Date 10

 3.2.8 Time 10

 3.2.9 Parameter Resetting 11

3.3 GATE MENU 11

 3.3.1 Gate a Menu 11

3.3.1.1 Starting of Gate a 11

3.3.1.2 Width of Gate a 12

3.3.1.3 Height of Gate a 12

3.3.1.4 Mode of Gate a 12

3.3.1.5 Display Choice 12

3.3.2 Gate B Menu 13

3.3.2.1 Starting of Gate b 13

3.3.2.2 Width of Gate b 13

3.3.2.3 Height of Gate b 13

3.3.2.4 Mode of Gate b 14

3.3.2.5 Measuring Point 14

3.4 PROBE MENU 14

3.4.1 Dual Probes 14

3.4.2 Probe Zero 15

3.4.3 Probe K Value 15

3.4.4 Front Distance 15

3.4.5 Work Piece Thickness 16

3.5 CURVE MENU 16

3.5.1 DAC echo 16

3.5.2 Gate A start 17

3.5.3 RL 17

3.5.4 SL 17

3.5.5 EL 17

3.6 MEMORY MENU 17

3.6.1 Memory Number 18

3.6.2 Call-out 18

3.6.3 Storage 18

3.6.4 Deletion 18

3.6.5 Communication 19

3.7 OPERATION OF OTHER SPECIAL FUNCTIONAL KEYS 19

3.7.1 Automatic Gain 19

3.7.2 Freezing 20

3.7.3 Wave Peak Memory 20

3.7.4 Full Screen 20

CHAPTER 4 APPLICATION OF TESTING 20

4.1 CALIBRATION METHOD AND STEPS OF THE INSTRUMENT 20

4.2 ZERO CALIBRATION OF THE STRAIGHT BEAM PROBE 21

4.2.1 Calibration Procedures 21

4.2.2 Operation Steps 21

4.2.3 Measurement of the Sound Velocity of the Material 23

4.3 CALIBRATION OF THE ANGLE BEAM PROBE 23

4.3.1 Calibration Procedures 23

4.3.2 Operation Steps 23

4.4 MAKING OF DAC CURVE 27

CHAPTER 5 SKILLS OF USING THE INSTRUMENT28

5.1 FLEXIBLE USAGE OF THE GATE28

5.2 MAKING THE BEST OF THE PROMPTING MESSAGES ON THE SCREEN DRUING THE OPERATION PROCESS28

5.3 SAVING AND CALLING THE INSTRUMENT STATUS AND THE DETECTION PARAMETERS.....28

5.4 USING BATTERIES TO REDUCE INTERFERENCE29

5.5 SWITCHING THE DISPLAY MODES29

5.6 PEAK VALUE MEMORY FUNCTION29

CHAPTER 6 APPLICATION AND PRACTICE OF FLAW DECTETION30

6.1 APPLICATION ON STEEL PLATE FLAW DETECTION30

6.1.1 The adjustment of testing scope30

6.1.2 The adjustment of sensitivity30

6.1.3 the identification of flaws.....31

6.1.4 Flaw Evaluation31

6.1.5 Flaw Quantify31

6.1.6 the identification of the defect location31

6.2 THE APPLICATION ON THE WELDING LINE FLAW DETECTION.....32

6.2.1 Operating steps.....32

6.2.2 Measurement of the flaw length.....33

CHAPTER 7 MAINTENANCE AND REPAIRING33

7.1 OPERATORS’ TRAINING33

7.2 INSTRUMENT MAINTENANCE34

7.3 ENVIRONMENT REQUIREMENTS.....34

7.4 MAINTENANCE OF RECHARGEABLE BATTERY34

7.5 BATTERIES REPLACEMENT.....35

7.6 REPAIRING.....35

CHAPTER 8 COMMUNICATION BETWEEN THE INSTRUMENT AND THE COMPUTER36

8.1 THE COMMUNICATION BETWEEN YUT-2600 AND THE COMPUTER AND THE USE OF DATA PROCESSING SOFTWARE.....36

8.2 MAIN FUNCTIONS37

APPENDIX I FLAW DETECTION REPORTS38

APPENDIX II TERMILONOGY39

Chapter 1 A Brief Introduction to YUT-2600

1.1 Names of the Major Components of the Instrument

The names of the major components of the instrument are shown in Figure 1-1.

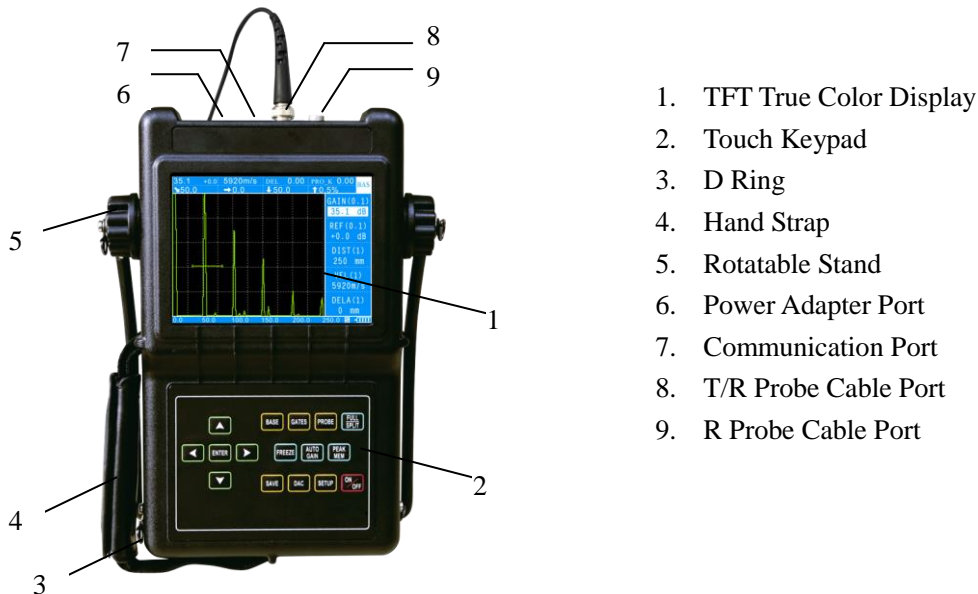

1. TFT True Color Display
2. Touch Keypad
3. D Ring
4. Hand Strap
5. Rotatable Stand
6. Power Adapter Port
7. Communication Port
8. T/R Probe Cable Port
9. R Probe Cable Port

1.2 Keypad

The keypad plays a role of mediator in the dialogue between human and machine. The keypad is printed in Chinese and the layout of the keypad is shown in Figure 1-2. All the control instructions given by the user to the flaw detector are finished entirely by the keypad. With the process of the keypad operation, the instrument is able to identify various meanings of each key according to different conditions and then to carry out the instructions of the operator. The detailed usage of each key will be introduced respectively in the following chapters.

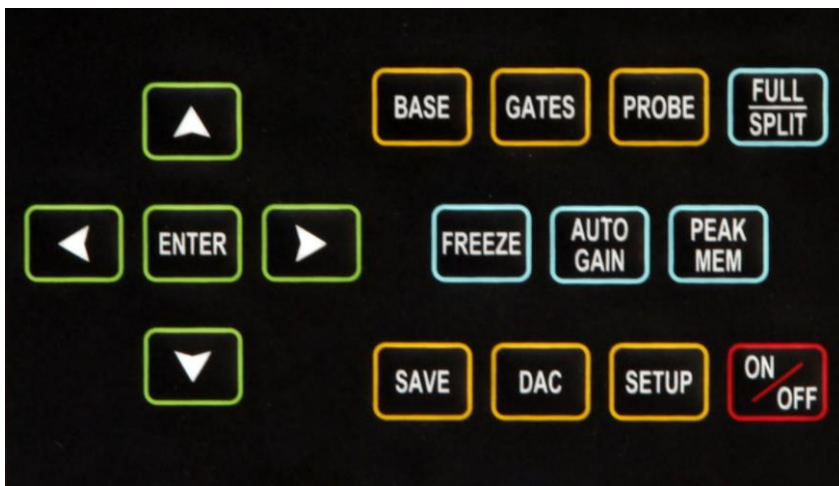



Figure 1-2

1.3 Display Screen

Press  to power the instrument on (the probe is not connected), and the screen is shown as Figure 1-3.

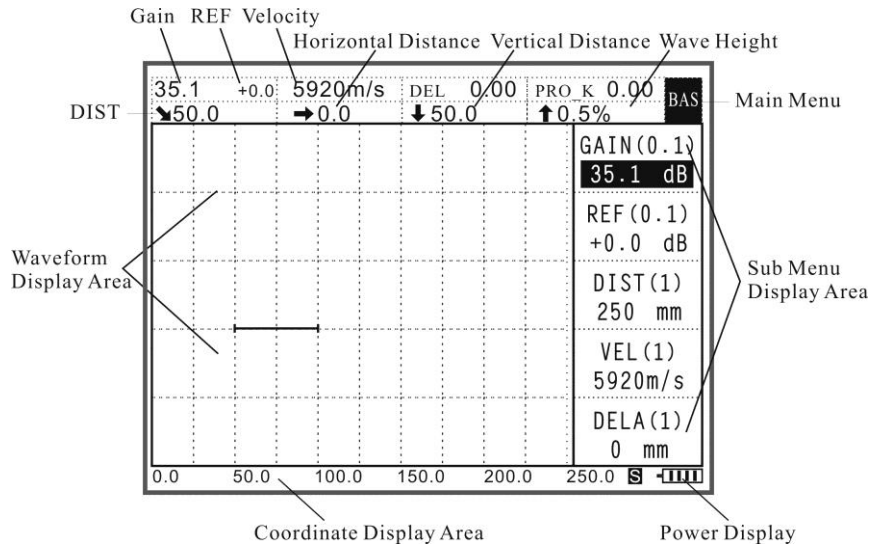

Figure 1-3

1.4 Basic Operation of the Instrument

During the operation of the instrument, directly press the corresponding menu key, and the relevant menu will be displayed on the screen. There are 6 main menus in YUT-2600; and each main menu consists of several sub-menus, which can be switched through up and down keys among the operation pages. The selected menu is highlighted; and its value can be adjusted through left and right keys.

1.4.1 Power Supply

Using AC Adapter

Alternating current can be used to power YUT-2600 through an AC adapter. Plug the power output terminal of the AC adapter into the socket on the YUT-2600. **Pay attention to alignment of the red spots on the socket when connecting the charger and the main unit.** Otherwise, the instrument doesn't work.

Using Batteries

A pack of exclusive rechargeable built-in batteries can be used in YUT-2600, as shown in Figure 1-4.





Figure 1-4

1.4.2 Probe Connection





When you use YUT-2600, we recommend using our stock probe connecting cable with the appropriate probes. Various types of our standard stock probes can be used directly.

The probe should be plugged into the socket upside the instrument. When it is the mode of single probe, the probe cable should be connected to T/R socket; when it is the mode of dual probe (one for transmitting, the other for receiving), you should plug the transmitting probe into the T/R socket and the receiving probe into the R socket. If these factors are not paid attention to, unfavorable results might be loss or disordered echo waveform.

1.4.3 Switching On and Off the Instrument

Press  to directly start up YUT-2600 and activate the standby mode. After the detection and data storage, press  to shut down the instrument.

1.4.4 Restore the Initial Parameters of the Instrument

If the instrument crashes or some functions are in disorder or the parameters of the instrument need resetting, press  twice before press  (up) key or  (down) key to select the submenu resetting parameters. Then press  (left) key or  (right) key to adjust the parameters. When the screen displays resetting parameters confirmation, press Ok to restore the parameters.

Note: after the instrument is initialized, all the parameters are reset to the factory defaults.

1.5 Main Menu and Functions

1.5.1 Main Menu

Main Menu	Submenu Functions	
Basic	Gain, Compensation, Sound Velocity, Sound Path, Displacement, Scale, Reject, Wave Height Readings	Basic Parameters in Detection
Setting	Waveform Filling, Color Scheme, Language, Unit, Alarm, Automatic Wave Height, Date, Time, Parameter Resetting, Lighting	Basic Functions of the Instrument
Gate	Gate A Start, Gate A Width, Gate A Height, Gate A Mode, Display Mode, Gate B Start, Gate B Width, Gate B Height, Gate B Mode, Measurement Point	Relevant Options Setting Gate
Probe	Dual Probes, Probe Zero, Probe K Value, Front Edge Length, Work Piece Thickness	Relevant Options Setting Probe
Curve	DAC Echo, Gate A Start Position, RL, SL, EL	Setting of Making DAC Curve
Storage	Memory Number, Call Out, Storage, Deletion, Communication	Setting of Data Storage

1.5.2 Functional Keys

Automatic gain	Increase or decrease the highest wave inside the gate to 80% of the screen
Freezing	Waveform freezing
Wave Peak Memory	Automatically store the highest wave
Full screen	Full screen display
On/off	Switch on and off
Menu control keys Up, down, left, right, Ok	Up/down keys are used to switch among options, left/right keys are used to adjust values.

Chapter 2 Functions, features, and parameters of the instrument

2.1 Basic functions of the instrument

Wave peak memory: real time envelopes show the highest wave of the flaws and record the maximum value of the flaws, it is helpful to position the flaws precisely and scan the work piece quickly. With the help of envelope waveform, the quality of the flaws can be determined.

Automatic gain: automatically adjust the gain to the preset amplitude height

Alarming function: afferent echo/echo loss alarming

Real-time clock: automatically record and store the date and time of waveforms

Display freezing: catch waveforms and sound path data at any moment, and the gate can be moved after freezing to measure the echo parameters

Flaw positioning: real-time display sound path S, horizontal X, depth Y, and wave height H

Digital Reject: 0-80%, increase by 1%, unaffecting the linearity and gain

Wave height reading: three display modes, namely relative wave height, dB difference relative to the gate, and dB difference relative to DAC curve

Data communication: communicate with the computer through RS232 port to transmit waveforms and data so as to manage the result of detection on the computer, and generate the flaw detection reports, as well as print out reports

2 independent measurement gates, monitoring the echo amplitude and the sound path distance

When using transverse wave to detect flaws, the depths of the second and third waves are automatically calculated according to the slab thickness.

Perfect DAC/AVG curve functions, the curves change along with the changes of the gain, sound path, and displacement

2.2 Features of the instrument

The firm and durable YUT2600 are specially designed for the hostile site environment. The pan-seal design which is particular in the nation enables it to defend against dampness, sandstorm, dust, or pollution caused by all sorts of harsh environments from sea to desert.

- Pan-seal design, including tool housing, battery case, fastening screws, and external interface
- 31 copper screw nuts are inlaid in the hard plastic casing
- The innovative rotating positioning stand is convenient
- The hand strap can be installed for both hands so that you can hold the machine with your left or right hand

- The probe interface is optional for BNC or Lemo
- The D-shaped ring on the instrument is convenient for you to install a cheststrap
- The nice surface of the casing is antiskid with eroded textures
- Innovative high power lithium batteries of notebook style

Full screen function, the echo display area can cover the entire screen, which provide you with the sense of the maximum window

Solid waveform display, the visual contrast of waveforms is increased so the undetection is hard to happen when fast scan is carried out

Bulk storage, up to 1000 data sets can be stored, including waveforms, curves, and parameters (containing the traditional 1000 channels)

Echo-echo thickness measurement, zero calibration is avoided, and the net thickness of the base material can be directly measured through the coating

Two operation interfaces are available, i.e., Chinese and English

Easy to use, the user can master the operation method very fast

2.3 Specifications

Working frequency: (0.5-15) MHz

Detection coverage: (0-177) inch

Sound Velocity of the Material: (0.039 to 0.394) inch/ μ s

Operation mode: pulse echo, dual crystal

Pulse displacement: (0-78.7) inch

Probe zero: (0-99.99) μ s

Damp: 33/50/100/500 Ω

Gain adjustment: (0-110)dB, 0.1dB、1.0dB、2.0dB、6.0dB Full automatic adjustment of steps

Reject scope: 0-80% adjustable

Vertical linearity error: $\leq 3\%$

Horizontal linearity error: $\leq 0.3\%$

Resolution: ≥ 32 dB (5P14)

Dynamic range: ≥ 30 dB

Sensitivity allowance: ≥ 55 dB (0.787" deep $\Phi 2$ Flat-bottom hole)

Data storage: 1000 data sets, including flaw detection status parameters, echoes, DAC curves

Average electric noise and level: $\leq 10\%$

Battery types: high power lithium battery

Power supply: 220VAC, 11VDC

Working hours of the batteries: 8 hours.

Casing: pan-seal design of IP67 standard, real waterproof, dampproof, and dustproof.

External dimension: 10.63"X7.48"X2.36"

Weight: 1.4kg without batteries

Working temperature: 14°F to 122°F





Chapter 3 Detailed Operation Instructions

3.1 Basic Menu Functions

Press  to start the menu.

3.1.1 Sound Path





On the sound path submenu, you can make the adjustment of the display range, i.e., the frequency of the echo displayed. The range is from 25 to 4500mm.

On the parameter menu, press  (up) or  (down) to select the sound path submenu, then press  (left decrease) or  (right increase) to adjust the values.

On the sound path submenu, press OK  to adjust the steps. The steps are 1, 10, 25, and 100.

3.1.2 Sound Velocity

On the sound path submenu, you can adjust the velocity of the ultrasonic wave transmitted in the detected work piece. The range of adjustment is from 1000 to 9999m/s.

On the parameter menu, press  (up) or  (down) to select the sound path submenu, then press  (left decrease) or  (right increase) to adjust the values.

On the sound velocity submenu, press  to adjust the steps. The steps are 1, 10, 100 and V-V. When V-V is selected, you can switch between two preset velocities, namely 5920m/s or 3240m/s.





The Sound Velocities of Some General Materials

Materials	Transverse Sound Velocity	Longitudinal Sound Velocity	Materials	Transverse Sound Velocity	Longitudinal Sound Velocity
Copper	2260m/s	4700m/s	Organic Glass	1460m/s	2730m/s
Aluminum	3080m/s	6300m/s	Steel	3230m/s	5920m/s
Iron	3230m/s	5900m/s	Epoxy Resin	1100m/s	2500m/s

3.1.3 Displacement

The displacement submenu displays the starting point of the screen. When the value is adjusted, the





waveform will move horizontally. The adjustment range is from 0 to 2000mm.

On the parameter menu, press  (up) or  (down) to select the displacement submenu, then press  (left decrease) or  (right increase) to adjust the values.

On the displacement submenu, press OK  to adjust the steps. The steps are 1, 10, 25, and 100.

3.1.4 Gain





The gain submenu enables you to adjust the sensitivity of the instrument. Its unit is dB. The higher is the gain, the more sensitive the instrument is, and vice versa. The adjustment range is from 0 to 110dB.

On the parameter menu, press  (up) or  (down) to select the gain submenu, then press  (left decrease) or  (right increase) to adjust the values.

On the gain submenu, press Ok  to adjust the steps. The steps are 0.1, 1.0, 2.0 and 6.0.

3.1.5 Compensation





Owing to the different degrees of roughness of surface of the detected object and the test block calibrating the instrument, in the practical detection, you need to increase (or decrease) the sensitivity of instrument to reduce the influence caused by the surface of the detected object. The range of adjustment is from -40 to +40 dB. The values used in the adjustment are related to the gain values.

On the parameter menu, press  (up) or  (down) to select the compensation submenu, then press  (left decrease) or  (right increase) to adjust the values.

On the compensation submenu, press Ok  to adjust the steps. The steps are 0.1, 1.0, 2.0 and 6.0.

3.1.6 Scale

This function enables you to adjust the display mode of the screen coordinate.

On the parameter menu, press  to activate the function. Press  (up) or  (down) to select the scale submenu, then press  (left) or  (right) to switch among various display modes.





S Sound Path: the actual distance of the sound wave from the surface of the work piece to the flaw.

X Horizontal Distance: the horizontal distance of the sound wave from the point of incidence to the flaw.

Y Vertical Distance: the vertical distance of the sound wave from the surface of the work piece to the flaw.

3.1.7 Reject

After you adjust to a value, the echo below the value can be cleaned. For instance, you can remove the structural noise of the detected work piece. The reject setting is shown by % on the screen, and the adjustment range is 0-80%.

On the parameter menu, press  to activate the function. Press  (up) or  (down) to select the reject submenu, then press  (left) or  (right) to adjust the values.

You should handle this function with great caution, as it may happen that you suppress echoes from flaws as well. In addition, some specifications expressly forbid using the reject function.

3.1.8 Wave Height Readings

Ha% The percentage of the waveform accounting for of the screen height in windows.

dBa The dB difference of the waveform relative gate can be shown in windows. When you use this function, you should use Gate A to catch the echoes. Otherwise, it will result in error in reading.

SL In the windows, the dB difference of the quantitative line relative to DAC curve will be shown. If there is no DAC curve, then it displays SL ----.





Hint: on the parameter menu, the 8 submenus are shown on two screens - the former five ones on one screen, and the latter three ones on the other screen. You can switch among them by pressing .

3.2 Setting Menu

Press  to select the setting menu.

3.2.1 Waveform Filling



This function enables you to adjust the waveform displaying mode.

Select the setting menu, press  (up) or  (down) to select the waveform filling submenu, then press  (left) or  (right) to select off or on. Off refers to enveloping, and On refers to filling.

3.2.2 Color Scheme





You can use the function to adjust the colors on the screen.

Select the setting menu, then press  (up) or  (down) to select the color scheme submenu.

Then press  (left) or  (right) to choose one of seven color schemes.





3.2.3 Language

You can use this function to choose a language.

Select the setting menu, then press  (up) or  (down) to select the language submenu. Then press  (left) or  (right) to choose Chinese or English.





3.2.4 Alarming

You can use this function to set whether there is an alarm.





On the setting menu, press  to activate the function. Press  (up) or  (down) to select the alarming submenu. Then press  (left) or  (right) to set the alarm. Off refers to turning off the alarm, while On refers to turning on the alarm.

3.2.5 Automatic Wave Height

You can use this function to set the percentage of the height of the automatic gain waveform on the screen. The default status is 80%.





Select the setting menu, press  (up) or  (down) to select the automatic wave height submenu. Then press  (left) or  (right) to adjust the values. The maximum value is 80%, while the minimum is 20%.

3.2.6 Date

On the setting menu, press  to activate this function. Press  (up) or  (down) to select the date submenu. Then press  (left) or  (right) to set the date.





Press Ok  to switch among year, month, and day.

3.2.7 Time

On the setting menu, press  to activate this function. Press  (up) or  (down) to select the time submenu. Then press  (left) or  (right) to set the time.

Press Ok  to switch among hour, minute, and second.

3.2.8 Parameter Resetting

Select the setting menu, press  (up) or  (down) to select the parameter resetting submenu. Press  (left) or  (right) to choose whether to reset the parameters, and press  to reset the factory defaults. If you want to cancel the resetting, press any key.

In the setting menu, 10 submenus are displayed on two screens, the former five ones on one screen and the latter five ones on the other. You can switch among them by pressing .

3.3 Gate Menu





The most outstanding feature of the digital flaw detector is the ability to display all the analogue values of echoes on the screen by digital signals. When the instrument is required to compare and compute a signal wave, "human" is needed to tell it which echo to trace. We appoint "gate" for locking the echo to be measured. The instrument handles and computes the echo inside the gate as well as displays all the data of the highest echo (including data of the sound path, the horizontal distance, the vertical distance, and the height).

The instrument works in a dual-gate mode with Gate A and Gate B. The reading mode of the gate is single gate one. The user can choose Gate A as the current gate. Next, we are going to introduce the adjustment of the position, width, and height of the gate based on the current gate.

Press  to activate the gate menu. Press it for odd times to select Gate A, even times to select Gate B.





3.3.1 Gate A Menu

3.3.1.1 Starting of Gate A

Press  for odd times to select the Gate A menu, then press  (up) or  (down) to select the starting of Gate A submenu. Then press  (left) or  (right) to adjust the values.





Note: the starting of Gate A is the forward position of Gate A. The adjustment range: 0-9998mm. When you adjust the values, you can press Ok to adjust the steps which are divided into 1, 5, and 10.

3.3.1.2 Width of Gate A

Select Gate A menu, press  (up) or  (down) to select the width of Gate A submenu, then press  (left) or  (right) to adjust the values.





Note: the width of Gate A is the backward position of Gate A. Minimum adjustment range is 2mm, while the maximum one is same as the sound path value. When you adjust the values, you can press Ok to adjust the steps which are divided into 1, 5, and 10.

3.3.1.3 Height of Gate A

Select Gate A menu, press  (up) or  (down) to select the height of Gate A submenu, then press  (left) or  (right) to adjust the values.

Note: the height of Gate A is the response and measurement thresholds. You can adjust the value in the 2%-98% range of the vertical full-scale on the screen. When you adjust the values, you can press Ok to adjust the steps which are divided into 0.5, 2.5, and 5.

3.3.1.4 Mode of Gate A

Select Gate A menu, press  (up) or  (down) to select the mode of Gate A submenu, then press  (left) or  (right) to adjust the values.

Off Turning off the gate, ie, turning off the alarming and measurement functions.

Positive Afferent Echo Alarm. In the coverage of Gate A, if the echo exceeds the preset gate height, and the alarm is "on", the alarm will sound.

Negative Echo Loss Alarm. In the coverage of Gate A, if the echo is lower than the preset gate height, and the alarm is "on", the alarm will sound.

3.3.1.5 Display Choice





Select Gate A menu, press  (up) or  (down) to select the display choice submenu, then press  (left) or  (right) to adjust the values.

Note: when the function is off, the screen is closed. The other data is shown at the top right corner of the screen.

Display	Meaning	Display	Meaning
Sa	The sound path value of the echo in Gate A	Ha	The height of the echo in Gate A
Sb	The sound path value of the echo in Gate B	Hb	The height of the echo in Gate B
ba	The path difference of the echoes in Gate A and B	Da	The vertical distance from the surface of the work piece to the flaw echo in Gate A
Ra	The projection distance from the probe front edge to the flaw echo in Gate A.	Db	The vertical distance from the surface of the work piece to the flaw echo in Gate B
Rb	The projection distance from the probe front edge to the flaw echo in Gate B	dBa	The dB difference from the echopeak in Gate A to the gate level position
off	Close display	dBb	The dB difference from the echopeak in Gate B to the gate level position



3.3.2 Gate B Menu

3.3.2.1 Starting of Gate B

Press  for even times to select the Gate B menu, then press  (up) or  (down) to select the starting of Gate B submenu. Then press  (left) or  (right) to adjust the values.





Note: the starting of Gate B is the forward position of Gate B. The adjustment range: 0-9998mm. When you adjust the values, you can press Ok to adjust the steps which are divided into 1, 5, and 10.

3.3.2.2 Width of Gate B

Select Gate B menu, press  (up) or  (down) to select the width of Gate B submenu, then press  (left) or  (right) to adjust the values.





Note: the width of Gate B is the backward position of Gate B. Minimum adjustment range is 2mm, while the maximum one is same as the sound path value. When you adjust the values, you can press Ok to adjust the steps which are divided into 1, 5, and 10.

3.3.2.3 Height of Gate B

Select Gate B menu, press  (up) or  (down) to select the height of Gate B submenu, then press  (left) or  (right) to adjust the values.

Note: the height of Gate B is the response and measurement thresholds. You can adjust the value in the 2%-98% range of the vertical full-scale on the screen. When you adjust the values, you can press Ok to adjust the steps which are divided into 0.5, 2.5, and 5.

3.3.2.4 Mode of Gate B

Select Gate B menu, press  (up) or  (down) to select the mode of Gate B submenu, then press  (left) or  (right) to adjust the values.





Off Turning off the gate, ie, turning off the alarming and measurement functions.

Positive Afferent Echo Alarm. In the coverage of Gate B, if the echo exceeds the preset gate height, and the alarm is "on", the alarm will sound.

Negative Echo Loss Alarm. In the coverage of Gate B, if the echo is lower than the preset gate height, and the alarm is "on", the alarm will sound.

3.3.2.5 Measuring Point

You can use this function to set the measuring point position of the gate.

Select the Gate B menu, press  (up) or  (down) to select the measuring point submenu. Then press  (left) or  (right) to choose the values. The peak mode refers to the highest information of the echo in the gate, and the front mode refers to the first information when the echo goes through the gate.





Note: in the peak mode, the echo need not go through the gate; while in the front mode, the echo must go through the gate.

3.4 Probe Menu

Press  to select the probe menu.

3.4.1 Dual Probes

You can use this function to set the probe types.

Select the probe menu, press  (up) or  (down) to select the dual probes submenu. Then press  (left) or  (right) to adjust the values.

Note: On refers to the dual probes mode; while Off refers to the single crystal probe mode.

3.4.2 Probe Zero









There is a certain sound path distance between the probe chip and the coupling surface of the work piece to be detected, thus there will be a sonic time delay. The delay effect can be compensated by setting the probe zero submenu.

Select the probe menu, press  (up) or  (down) to select the probe zero submenu. Then press  (left) or  (right) to adjust the values.

Note: the adjustment range is 0-99.99 μ s. In the adjustment, you can press Ok to adjust the steps, which are divided into 0.025, 0.1, and 1.

3.4.3 Probe K Value





When the angle beam probe is used, the included angle value (β) between the sound beam in the work piece of the incidence of the sound wave and the surface normal should be set as: K value - $k = \text{tg}\beta$.

Select the probe menu, press  (up) or  (down) to select the probe K value submenu. Then press  (left) or  (right) to select the probe K value and the probe angle. Press  (up) or  (down) to select the value option, then press  (left) or  (right) to adjust the value.

Note: when you adjust the probe K value, press Ok to adjust the steps of the K value. When you adjust the probe angle, press Ok, then you are able to adjust the steps of the probe angle head. The steps of the K value are 0.01, 0.1, and 1. The adjustment range is 0-9.99. The steps of the angle are 0.1, 1, and 10. The adjustment range is 0-89.9.

3.4.4 Front Distance





In the menu, you can set the front edge length value of the probe (referring the distance between the front edge of the angle beam probe to the point of incidence of the probe).

Select the probe menu, press  (up) or  (down) to select the front distance submenu. Then press  (left) or  (right) to adjust the values.

Note: the adjustment range: 0-999.9mm. When you adjust the values, you can press Ok to set the steps, which are divided into 0.1, 0.5, and 1.

3.4.5 Work Piece Thickness

On the work piece thickness submenu, you can set the work piece thickness in the vertical direction of the detection plane. When using angle beam probe, the positioning of the vertical depth of the flaws need this value set. The reason is that when non-primary reflection is used in the detection, if the work piece thickness is not considered, it will result that the instrument might produce an outcome that the vertical depth value is larger than the actual thickness of the work piece when it automatically measure the vertical depth.

Select the probe menu, press  (up) or  (down) to select the work piece submenu. Then press  (left) or  (right) to adjust the value.

Note: the adjustment range: 0-999.9mm. When you adjust the values, you can press Ok to set the steps, which are divided into 0.1, 1, and 10.

3.5 Curve menu

Owing to the diffusion and attenuation of the sound velocity, the echo heights of the reflectors of the same size depend on the distance between the reflector and the probe. The distance amplitude curve is made according to different reference reflectors which are the same size but different in their depths, and a curve diagram mode displays the influences and the changes. When the DAC curve is being made, the material of the reference block with artificial flaws should be same as the work piece to be tested.

Note: When the DAC curve finished is activated, if you adjust some parameters, the prompt line will display "a DAC curve has been made, the parameter is locked", if you really need to change the parameter, you can close the DAC curve, and the DAC echo will be cleared. A new DAC curve will be made after the adjustment.

Press  to enter the DAC menu.

3.5.1 DAC echo

Select the DAC menu, press  (up) or  (down) to select the DAC echo submenu. Then press  (left) or  (right) to adjust the value.





Note: The functional option of the DAC echo is used to display the current number of the echo reference points, the maximum quality is 9, and confirm the echo reference points.

3.5.2 Gate A start

Select the DAC menu, press  (up) or  (down) to select the Gate A start submenu. Then press  (left) or  (right) to adjust the value.

Note: adjust the Gate A position to catch the reference echo. The adjustment range is 0-9999mm.3.5.3

3.5.3 RL

Press for twice to select the DAC menu, press  (up) or  (down) to select the RL submenu. Then press  (left) or  (right) to adjust the values.

Note: based on step of 0.5dB, you can adjust free in the range of -20dB -- +12dB above the DAC reference line. **DAC reference line:** a curve formed by the peak values of the echoes of the reference points recorded.

3.5.4 SL

Select the DAC menu, press  (up) or  (down) to select the SL submenu. Then press  (left) or  (right) to adjust the values.

Note: SL can be adjusted free in a range 12dB higher than the DAC reference line with a step of 0.5dB, or 20dB lower, but it can not be lower than the EL or higher than the RL.

3.5.5 EL





Select the DAC menu, press  (up) or  (down) to select the EL submenu. Then press  (left) or  (right) to adjust the values.

Note: based on step of 0.5dB, you can adjust free in the range of 0dB -- 20dB lower than the DAC reference line.

3.6 Memory Menu

Press  to enter the memory menu.



3.6.1 Memory Number

Select the memory menu, press  (up) or  (down) to select the memory number submenu. Then press  (left) or  (right) to adjust the values.

Note: the memory number can be chosen recurrently in the data set ranging from 1 to 1000. When setting the memory, if there is a  before the data set memory number, that means the data set is occupied. If you save the data, the original data will be covered. When you adjust the memory number, you can press Ok to set the steps, which are divided into 1, 10, and 100.



3.6.2 Call-out

After the data set is called out, the instrument parameters will be set same as those which are stored, and they will be displayed in freeze mode of the waveform stored.

First, set the memory number as the one you need, then select the option of call-out, press  (left) or  (right). When it comes to confirm calling out the file on the screen, press Ok to confirm and press any other key to cancel.

3.6.3 Storage

You can store the current parameter setting of the instrument, DAC curve and the waveforms into the data set of an appointed memory number.

First, set the memory number as the number you want, then select the option of storage, press  (left) or  (right). When it comes to confirm storing the file on the screen, press Ok to confirm and press any other key to cancel.

Note: if there is a  before the memory number, that means the data set is occupied. The storage will cover the stored data at this moment.

3.6.4 Deletion

First set the memory number, then select this option, press Ok to confirm, any other key to cancel. If there is a  before the memory number, that means the data set is occupied. You can delete the set.

3.6.5 Communication

The flaw detector can exchange data with PC. (For more information, see Chapter 8). The default status is on.

3.7 Operation of Other Special Functional Keys

3.7.1 Automatic Gain

Move the gate to lock the echo that you want, as shown in Figure 3-1. Press  to start the automatic gain. The instrument will repeatedly compute the echo inside the gate automatically and adjust the gain automatically until the amplitude height of the largest echo is set to 80% of the screen height, as shown in Figure 3-2.

Note: the wave height after the automatic gain is related to the automatic wave height setting in the setting menu. If the automatic wave height is set as a certain value (in between 20%-80%), the wave height after the automatic gain is the height of the value on the screen.

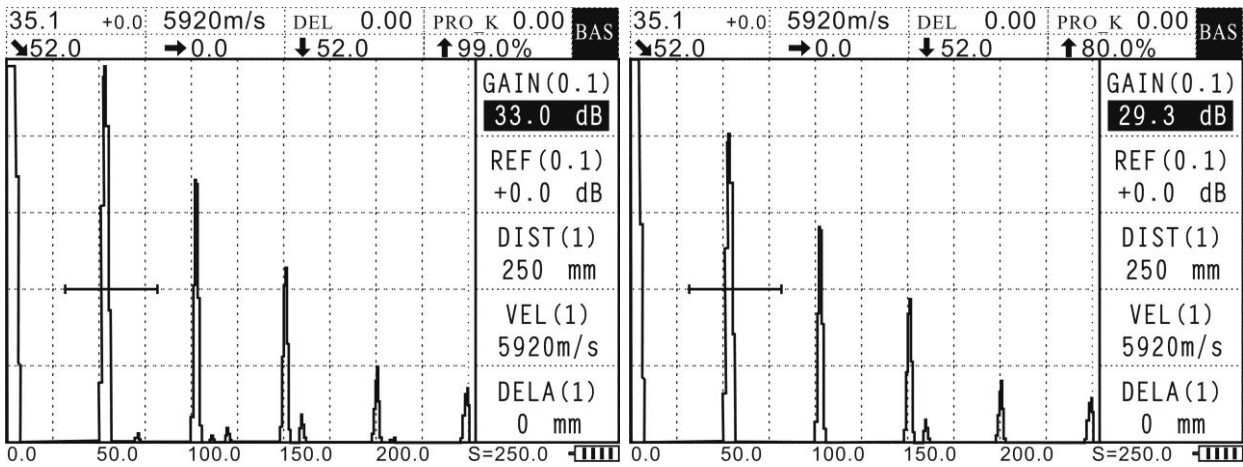

Figure 3-1

Figure 3-2

Note: When the DAC curve has been made, press the automatic gain, the instrument will automatically adjust the compensating gain so as to make the echo inside the gate reach 80% of the screen. The changes of echoes do not mean the changes of DAC curve. However, if the option is on the parameter menu and on the gain option, press the automatic gain, the instrument will adjust the gain automatically. The echo and the DAC curve change simultaneously.

3.7.2 Freezing



The function can freeze and lock the display on the current screen. In the freezing mode, you can move the gate to measure the echoed signal frozen on the screen.

If you want to freeze the current display, press . If you want to return the normal mode, press  again to unfreeze.



Note: in the freezing mode, all the adjustable parameters (gain, sound velocity) can not be adjusted.

3.7.3 Wave Peak Memory

Wave peak memory is a function that the instrument compares the “new” with the “old” highest dynamic echoes automatically and preserves the highest still echo.

First use the gate to lock the echo needed, press  to activate the wave peak memory status. When you move the probe, if there emerges a dynamic echo which is higher than the previous static wave displayed, the instrument can catch the new echo as the current highest echo displayed. Press  again to exit the wave peak memory.

3.7.4 Full Screen

Press  to enlarge the waveform display area to full screen so that you can observe the echo and the measurement values conveniently. At this moment, the main menu display is canceled. If you want to return to the normal display mode, press  again.

Note: in full screen mode, except the functions of automatic gain, wave peak memory, and freezing are available, other functions will be locked and unavailable.

Chapter 4 Application of Testing

4.1 Calibration Method and Steps of the Instrument

Before you use YUT-2600 to test the work piece, you should first calibrate the instrument: according to the material, size of the work piece to be tested as well as the relevant standards, choose the appropriate test method and probe, set the sound velocity, sound path of the material, set the working frequency and other

instrument parameters as well as the probe parameters, and adjust the probe zero.

First, according to the relevant industry standards or the requirements of the site, decide the test method and choose the appropriate probe.

4.2 Zero Calibration of the Straight Beam Probe

Concerning the contact method measurement by the straight beam probe of the general flaw detector, generally speaking, there is no emphasis on zero-bias control, as long as you aim the start pulse at the left side line of the display grid, any zero-bias can be ignored, this is acceptable in most cases. However, concerning the contact probe with a protective foil, owing to the time delay in the protective components, there might be a considerable zero-bias which affects the measurement of the the distance accuracy. In order to position the flaw to be tested, you should make a distance calibration before the measurement.

4.2.1 Calibration Procedures

In the parameter menu, set the sound velocity of the material given. If the sound velocity of the material is unknown, you should measure the sound velocity value of the material first. (Measurement of the sound velocity of the material)

In the parameter menu, set the sound path.

Put the probe on the calibration block (take CSK-1B) test block as an example, as shown in Figure 4-1), the coupling is favorable.

Lock the first echo with Gate A, then adjust the probe zero submenu on the probe menu till the measured data show the correct sound path value of the echo calibrated.

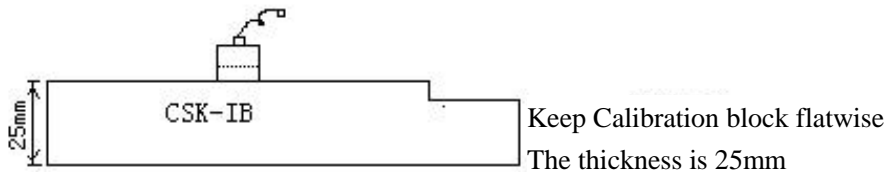

Figure 4-1

Note: the lower the sound path value is, the more accurate the calibration is.

4.2.2 Operation Steps

The instrument requires the echo with an known sound path as the calibration wave of the incident zero. We choose the CSK-1B test block kept flat to do the distance calibration, as shown in Figure 4-1.

1. Press **BASE** to enter the parameter menu, press **▲** (up) or **▼** (down) to select the sound path submenu. Then press **▶** (left) or **◀** (right) to set the value as 125mm.
2. Press **▲** (up) or **▼** (down) to select the sound velocity submenu. Then press **◀** (left) or **▶** (right) to set the value as 5920m/s.
3. Put the straight beam probe on the test block and keep good coupling, at this point, five echoes appear on the screen, as shown in Figure 4-2.

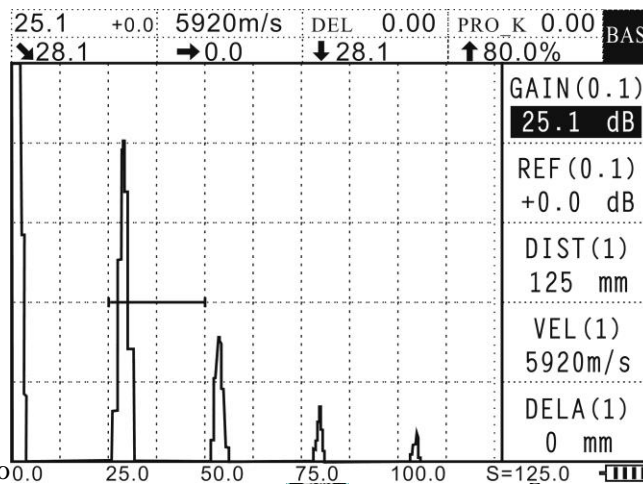

Figure 4-2

4. Set Gate A to 100.0 reach 80% of the screen. The sound path value is displayed on the screen. If the vertical sound path is not 25mm, press **PROBE**, then press **▲** (up) or **▼** (down) to select the probe zero submenu. Then press **▶** (right) to adjust the value till the vertical sound path is 25mm. At this point, the probe zero is the zero after calibration, as shown in Figure 4-3.

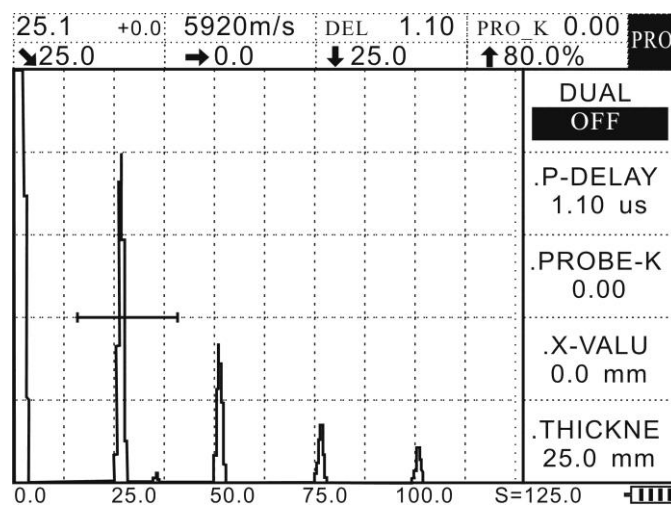

Figure 4-3

4.2.3 Measurement of the Sound Velocity of the Material

1. Set the approximate sound velocity of the material on the sound velocity submenu under the parameter menu;
2. Couple the probe to the known calibration position of the calibration block (the sound path is known), open Gate A, adjust the start position of the gate to let Gate A catch the primary echo; open Gate B and adjust the start position of the gate to let Gate B to catch the second echo.
3. On the gate menu, set the display as Sba, at this point, there appears a ba sign on the screen.
4. Increase or decrease the sound velocity value of the material till the ba value on the screen is equal to the sound path distance of the calibration block, at this point, the sound velocity is the sound velocity of the material.

4.3 Calibration of the Angle Beam Probe

Concerning the contact detection by angle beam probe, distance calibration is a must before any detection task. There are various kinds of angle beam probes with different structures and sizes, and different detection objects require different K values, thus the sound paths in wedge blocks are not same, in other words, the front edge length of each angle beam probe of transverse wave should be measured to decide the zero-bias value. Along with the probe abrasion during the usage, the angle beam probe need recalibration after a period time of usage.

4.3.1 Calibration Procedures

Set the sound velocity and sound path of the material known on the parameter menu, primary echo is adopted generally.

Calibration of the front edge of the probe;

Calibration of the zero of the probe;

Calibration of the probe K value (angle).

4.3.2 Operation Steps

Calibration of CSK-IA as an example.

1. Press **BASE** to enter the parameter menu, press **▲** (up) or **▼** (down) to select the sound path submenu. Then press **▶** (left) or **◀** (right) to set the value as 125mm.
2. Press **▲** (up) or **▼** (down) to select the sound velocity submenu. Then press **◀** (left) or **▶** (right) to set the value as 3240m/s.
3. Calibrate the front edge of the probe: put the probe on the test block and move it till the reflector echo of the hollows of R100mm reach the highest level, measure 89mm of the front face of the probe with a ruler, at this point, the front edge value of the probe is: $100-89=11$ mm. As shown in Figure 4-4, after that, press **PROBE** to enter the probe menu, then press **▲** (up) or **▼** (down) to select the probe front edge submenu, **▶** (left) or **◀** (right) to set the probe front edge value as 11mm, as shown in Figure 4-5.

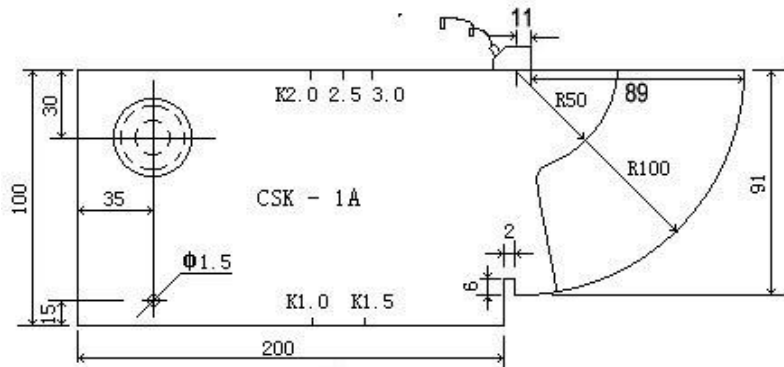

Figure 4-4

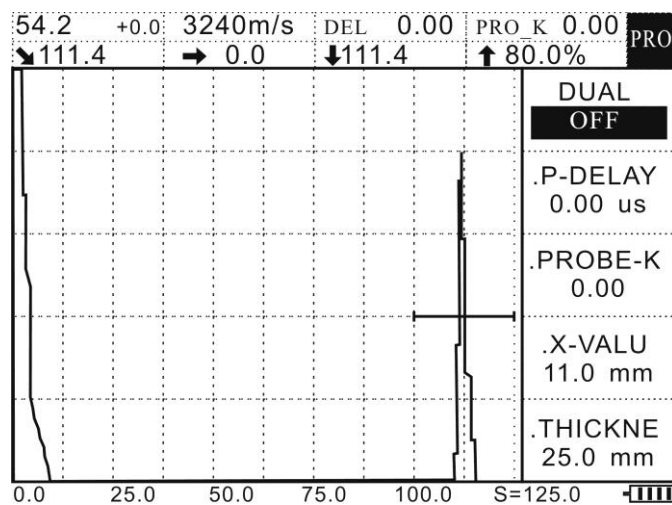

Figure 4-5

4. Calibrate the probe zero: put the probe on the test block and move it till the reflection echo of the hollows

of R100mm reaches its highest level. The sound path value will be displayed at the top left corner on the screen, if the value isn't 100mm, press **PROBE** to enter the probe menu, press **▲** (up) or **▼** (down) to select the probe zero submenu, then press **◀** (left) or **▶** (right) to set the value as 100mm. or direct press **PEAK MEM** to calibrate the probe zero automatically. As shown in Figure 4-6, the probe zero calibration is finished.

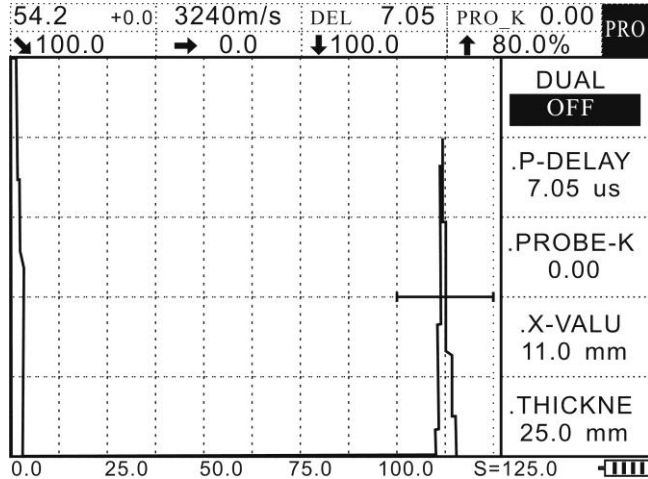

Figure 4-6

5. Calibrate the probe K value (angle): couple the probe to the CSK-1A test block and move it back and forth, as shown in Figure 4-7, till the reflection echo of the circle of $\phi 50\text{mm}$ reaches the highest level, use a steel ruler to measure L, and calculate K value according to $k=(L+X-35)/30$. As shown in Figure 4-9, press **PROBE** to enter the probe menu, press **▲** (up) or **▼** (down) to select the probe K value submenu, then press **◀** (left) or **▶** (right) to set the value as the K value calculated. As shown in Figure 4-9, or direct press **PEAK MEM** to calibrate the K value automatically.

Note: this method is adopted if a probe beyond K2 is used, if a probe below K2 is used, the other side should be adopted, as shown in Figure 4-8, the method is same, and the computing formula is $k=(L+K-35)/70$. L is the length from the front end of the probe to the test block boundary, X is the front edge value of the probe.

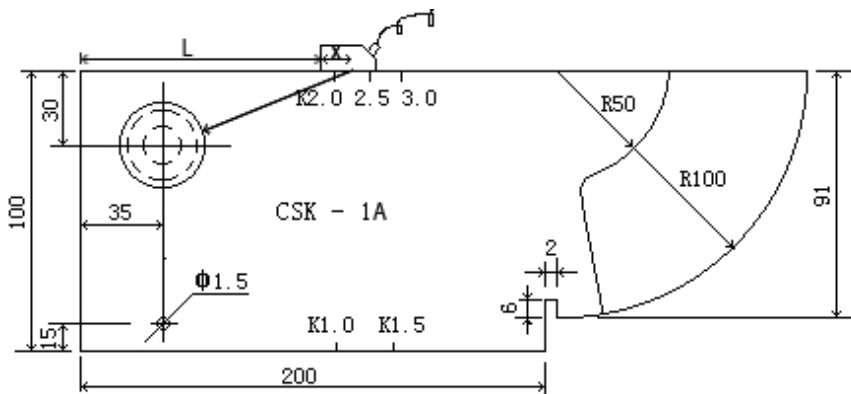

Figure 4-7

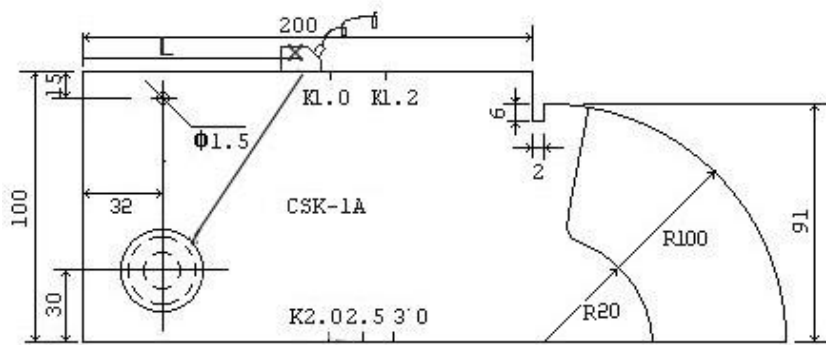

Figure 4-8

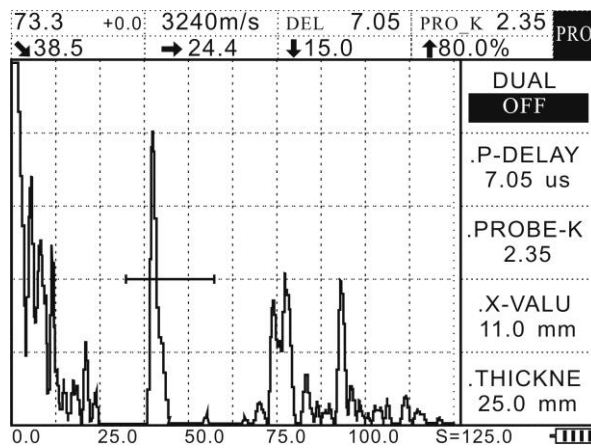

Figure 4-9

There are many ways to calibrate the angle beam probe, the standard test block isn't wedged to the calibration, and you can also use a pinhole of known depth to do calibration. Theoretically, the smaller reference reflector is, the more precise the calibration is, but the difficulty of calibration increases correspondingly. When you use a pinhole to do calibration, you can measure the depth and the horizontal position of the pinhole to calculate the slope coefficient to calibrate the angle, and then you can use the depth or the horizontal position value that you measure to calibrate the sound velocity and the probe zero.

4.4 Making of DAC Curve (NB/T 47013-2015 by CSK-IIA block)

1. First calibrate the probe as above mentioned
2. Couple the probe to the reference block to make the echo of the first reference point reach the highest level (we use CSK-III A test block as an example, as shown in Figure 4-10).

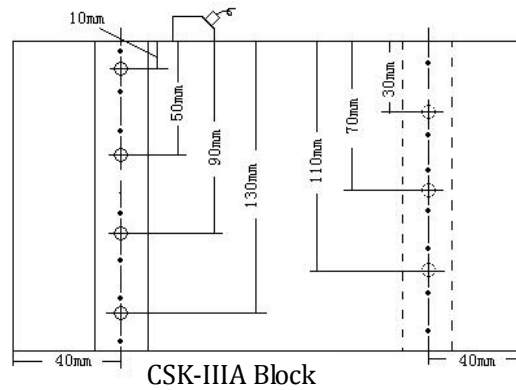









Figure 4-10

3. Press the start menu of Gate A to set its position and lock the echo, press  to let the echo display 80% of the screen automatically when it is the highest wave.
4. Press  and press  again when the first DAC curve is displayed on the screen, the value of the DAC echo on the submenu is 1 automatically.
5. Move the probe to make the level of the echo of the next reference point be highest, move the gate to catch the echo, and repeat step 4. At this point, the value of the DAC echo on the submenu is 2 automatically.
6. During the recording, if you find there is something wrong with the newly-recorded reference point, on the DAC submenu, press  to delete this point.
7. The other points can be handled in the same way. The instrument can measure nine point at most. The general order of the test points is (10mm, 20mm, 30mm, 40mm ...).
8. After all the reference points are recorded, a curve is displayed on the screen, press  (up) or  (down) to set it on RL, then press  (left) or  (right) to set the corresponding value. SL and EL can be handled in the same way.

Chapter 5 Skills of Using the Instrument

When you use the instrument to detect the work piece, it is very necessary to make full use of all sorts of powerful functions of the instrument to guarantee the accuracy of the detection and to improve efficiency. Next we are going to focus on and explain the flexible usage of some important functions of the instrument.

5.1 Flexible Usage of the Gate

By adjusting the start of Gate A, its width, and its height, you can use Gate A to catch the echo signal to be measured, you can also directly read the sound path, the horizontal distance, the vertical distance, and other values of the echo inside the gate on the screen.

By setting the gate mode, you can set Gate A and B as the afferent echo alarm gate and the echo loss alarm gate.

5.2 Making the best of the prompting messages on the screen during the operation process

When you operate the instrument and some operations need confirming by the operator, on the upper part of the screen displays the prompting messages.

Examples are storage, deletion, freezing, etc, when you operate the instrument, there will be corresponding prompts on the screen.

5.3 Saving and calling the instrument status and the detection parameters

The instrument is able to store 1000 sets of detection status data (including echo waveforms, DAC, etc). Therefore, you can store the detection status data and DAC curves which are calibrated well for different probes or various work pieces into different records, and you can call out the corresponding saved record before detection. The detection can start as soon as the data are unfrozen so that you can switch among different detection statuses. It is easy for management, and at the same time, the complicated calibration work is alleviated.

5.4 Using batteries to reduce interference

When the AC mains are disturbed by the strong interference signals, you should use batteries. By using batteries, you can cut off the interference signals in the AC mains effectively, and other external interference signals will not influence the instrument. When you work in an outdoor place, you should prepare spare batteries.

5.5 Switching the display modes

In the normal display mode as shown in Figure 5-1, press full screen, the echo display will be enlarged to the entire screen, at this point, the main menu and the submenu are hidden as shown in Figure 5-2. In the full screen mode, except the functions of automatic gain, wave peak memory, and freezing are available, other functions will be locked and unavailable. This feature is helpful to prevent maloperation when the detection is on site. If you want to return the normal mode, press the full screen again. After the instrument has been calibrated, and when you start detection, you can switch to the magnification display mode to observe the echo conveniently.

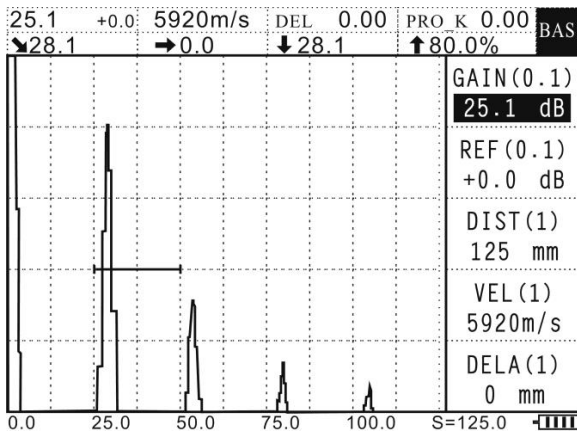

Figure 5-1

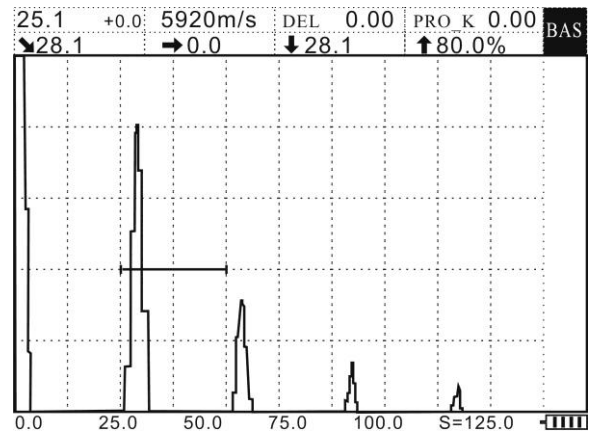

Figure 5-2

5.6 Peak value memory function

When the function is enabled, the screen will record the highest point of the echo and joint all the points with dashed line to form an envelope line, when a higher echo emerges, it will refresh the memory point at this position, otherwise, it keeps unchanged.

Chapter 6 Application and Practice of Flaw Detection

This chapter introduces how to use YUT-2600 to test steel plate and welding line. This chapter is based on the flaw detection methods and reports forms authorized by the National Nondestructive Testing Personnel Qualification Test Committee. (Testing criterion is NB/T47013-2015).

6.1 Application on steel plate flaw detection

Using straight probe to detect the flawed area is the main application of the instrument for detecting flaws of steel plate, which requires operators to identify and quantify the flaws.

6.1.1 The adjustment of testing scope

The adjustment of testing scope is mainly based on the thickness of the steel plate. By adopting contact method, when the thickness of the steel plate is less than 30mm, B10 can be seen and the testing scope should be adjusted to about 300mm. When the thickness is between 30-80mm, B5 can be seen and the testing scope should be about 400mm. When the thickness is more than 80mm, the frequencies of bottom waves should be reduced while the testing scope should remain about 40mm.

6.1.2 The adjustment of sensitivity

Take flat-bottom test block as an example to illustrate the adjustment of sensitivity here. When the thickness of the steel plate is more than 20mm, use the 50% first echo of $\phi 5$ flat-bottom test block as the required sensitivity.

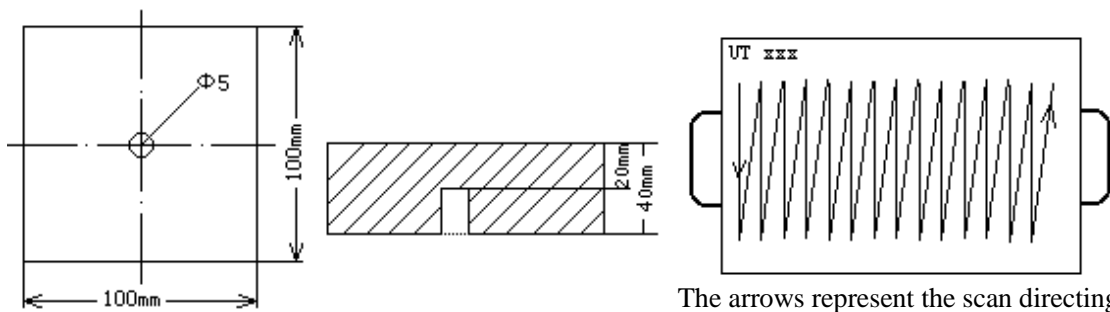

Put the probe on the flat-bottom test block, move the probe to find out the biggest echo of $\phi 5$ flat-bottom hole. Press **BASE** to enter the parameter menu. Use the direction keys to adjust Gain and set the first echo to

50% of the scale. The readings of the gain is the sensitivity degree of flaw detection. Finally scan and detect flaws by putting the probe on the steel plate to test.

6.1.3 The identification of flaws

In the process of flaw detection, observe the waveform on the screen to judge the flaws according to the flaw waves and bottom waves. According to NB/T47013-2015, the following situations can be identified as flaws.

The first reflected waves of flaws $F1 \geq 50\%$.

First bottom waves $B1 < 100\%$, the ratio between first flaw waves $F1$ and first bottom waves $B1$ being $F1/B1 \geq 50\%$.

First bottom waves $B1 < 50\%$.

6.1.4 Flaw Evaluation

When the flaws is identified during the detecting process, it is necessary to evaluate the location, size and estimate the nature of the flaw.

6.1.5 Flaw Quantify

Length testing method is usually adopted to test its length and area in steel plate flaw detection. According to NB/T47013-2015.

When $F1 \geq 50\%$ or $F1/B1 \geq 50\%$ ($B1 < 100\%$), the distance between the probe centers when $F1$ is 25% and $F1/B1$ is 50% is the length of defect pointer, and the probe center orbit is the defect edge.

When $B1 < 50\%$, the indicated defect length is the distance the probe center covers when $B1 = 50\%$. The orbit of the probe center is the defect edge.

During the process of scanning and detecting, when any above situation occurs, take off the probe and mark the boundary point with a marker pen. Then repeat this until other boundary points are identified. (about 8 points will be adequate to identify the defect area)

6.1.6 the identification of the defect location

Identify the defect location by the position of the probe which detected flaws and mark the workpiece. Then measure the minimum distance $L1$ between the left side of the steel plate and the flaw, the minimum

distance between the down side of the steel plate and the flaw, and the maximum indicated length L3. Based on the figure, work out the defect area. See the picture below:

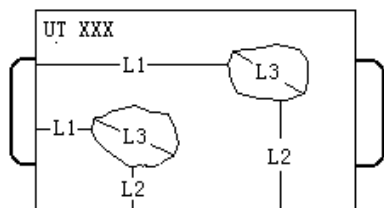

Fill in the figures tested :

number	L1 (mm)	L2 (mm)	L3 (mm)	S1 (mm ²)	The percentage of any 1×1 area	rating	remarks
1							
2							

6.2 The application on the welding line flaw detection

The following figure should be recorded when detecting the flaws in welding lines

num ber	S1	S2	length (L)	The distance between the flaw and the welding line center (mm) q		The depth between the flaw and the welding line surface (mm) H	S3	The value higher than the quantifying line dB (Amax)	Wave height area
				A (+)	B (-)				
1									
2									
3									

Note: S1: the distance between the flaw starting point and the left datum line of the test block

S2: the distance between the flaw ending point and the left datum line of the test block

S3: the distance between the highest point of the amplitude and the left datum line of the test block

6.2.1 Operating steps

According to the adjusting methods of angle probes stated above, start the welding line flaw detecting after the curved lines have been drawn. According to the NB/T47013-2015, type in the criterion of the curved lines based on the thickness of the workpieces. (When $6\text{mm} < T < 40\text{mm}$, it is evaluated as disabled: -4B), quantification: -12dB, evaluation: -18dB, surface compensation is +4dB. For testing easily, the gate can be widened to avoid moving it. See the operating methods in Gating Operations.) After typing in the

criterion, put the probe on the workpiece to test for scanning and detecting. The directions of the arrow shows the scanning and detecting directions.

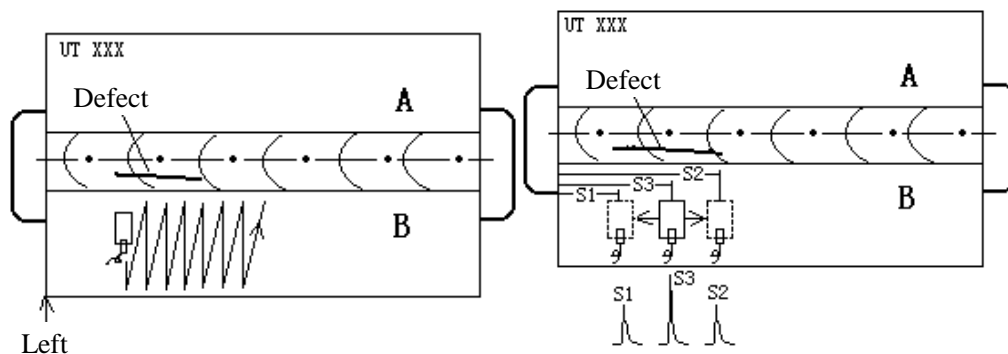

When you find flaws, you should observe the echo height. If the echo height exceed SL. Now carefully move the probe to find the highest echo. After you find the highest wave, keep the probe steady. Now observe the data display area on the screen to get the flaw depth reading \downarrow x.x, ie, H, as well as the area where the wave height is. Use a steel ruler to measure the distance from the probe to the left end of the steel plate, ie S3, (measure form the center of the probe, or measure from the left side of the probe, then plus 1/2 of the probe width). Observe the data display area on the screen again to get the flaw level readings \rightarrow x.x. Use a steel ruler to measure the position of the flaw from the leading end of the probe, and use the steel ruler to measure the distance between the flaw position and the axis of the weld, as shown in the above figure. If the measured distance is 3mm, and the flaw is nearer to the axis of a weld B (-) side, then record as B3 or -3 (namely to fill 3 in the B column), at this point, the data of the flaw peak amplitude is recorded.

6.2.2 Measurement of the flaw length

Press **AUTO GAIN**, set the flaw highest wave to 80% of the full scale, then move parallel the probe to the left, and observe the echo on the screen. When the echo drops to 40%, (namely half of the highest wave). Measure the distance from the probe to the left side of the steel plate and note down as S1. Then move parallel the probe to the right, back to the position of the highest wave, and keep moving the probe rightwards parallel till the echo drops to 40%. Then measure the distance from the probe to the left side of the steel plate, and note down as S2. Then subtract S2 from S1, the result value is the flaw length (L).

Fill the data measured above into the corresponding column in the table. According to the above-mentioned way to find the flaws and measure them.

Chapter 7 Maintenance and Repairing

7.1 Operators' Training

In order to operate the instrument correctly and safely, all operators have to accept formal skill

trainings on ultrasonic defectometer operation and study the Operator's Manual carefully beforehand.

Lacking special knowledge in ultrasonic flaws detecting may cause unpredictable erroneous results. To operate the instrument safely and correctly, please contact nondestructive testing organizations to require related information on training operators and on how to acquire certifications through related grade examinations.

7.2 instrument maintenance

Please use the standard connecting cables and communication cables and other accessories attached with the probes. Unmatched cables may result in electric circuit breakdown inside the instrument or cause damage to the sockets. Any liquid should be absolutely prevented from flowing into the instrument.

In the process of transporting or moving, don't drop and hit the instrument. Strong vibration, getting wet in snow and rain should be avoided.

The outside of the instrument should be cleaned each time after operation. Then put it at a dry and ventilated place indoors.

7.3 Environment requirements

The instrument should be strictly kept from collision, dust, humidity, magnetic fields and oil or grease.

Don't use anything soluble to wipe and clean the surface of the instrument.

7.4 Maintenance of rechargeable battery

The capacity and life span of rechargeable batteries depend on the way they are used. Please use the fast charger attached with the instrument to recharge the batteries.

Recharge the batteries under the following circumstances:

The battery status is constantly shown on the display screen. When battery voltage is too low, viz, the undervoltage sign is shown on the screen, recharge the batteries immediately or it will damage the batteries.

Please recharge the instrument every two months if it is put aside for a long time, for being in undervoltage condition for a long time may cause irrevocable damage to the instrument. If the batteries has run out, unplug the power adapter, and then plug it in two minutes later to continue to recharge the batteries.

Repeat until the batteries are back to normal again. The instrument can work will recharging.

7.5 Batteries replacement

The batteries in this instrument usually can be used for 3 years. When they don't work, users can replace them with batteries of the same type. Please follow the steps below:

- a. Unscrew the battery compartment behind the main unit.
- b. Uncover the battery compartment and take out the failed batteries.
- c. Install the recharged batteries correctly (Do not connect the wires inversely with the anode and the cathode of batteries).
- d. After the new batteries installed, turn on the power and check whether the instrument can work.
- e. Cover the battery compartment and tighten the screws.

Note: Please use the accumulator battery produced by our company when replacing it. If not, in the process of recharging or operating, flames or explosions may occur.

7.6 Repairing

In order to get the optimal performance of YUT-2600, and minimize its failure rate, the latest technology and quality components have been adopted. The process quality control and process testing have passed ISO9001 International Quality System Authentication.

Sudden failure

In case failure occurs, please turn off the power and take out the batteries when necessary. Then send the instrument to the appointed after-sales service center to have it repaired.

Under the following circumstances, the instrument won't work safely:

- a. The instrument suffered from evident mechanical damage. (For example it was badly collided or squeezed during the process of transportation.)
- b. The keyboard or the display screen can't work normally.
- c. It is kept in a place of high temperature, high humidity or corrosivity.

Chapter 8 Communication between the Instrument and the Computer

8.1 The Communication between YUT-2600 and the computer and the use of data processing software

The communication function means transporting the pre-saved waveforms and related parameters in the instrument into the computer and generating flaw detecting reports, which can enable the computer to control and manage the ultrasonic defectometer. It can realize single width transfer and continuous transfer.

Connect one end of the communication cable with the communication interface. The red pot of the interface should be aligned with the red pot on the instrument. The other end of the communication cable should be connected with the COM1 (or COM2) interface on the PC. The instrument will transmit the saved graphs and data to the PC. The client software installed on PC can edit, save or print these graphs and data.

Operating steps:

1. Connect the instrument and PC with the communication cable.
2. Press  to enter the save menu. Use the up and down keys to select the communication submenu. Use right and left keys to turn it on. Then the instrument is ready to connect the PC.
3. Open the communication software DDIClient.exe, and tap in the file scopes for download. Then press the download button.

Note: 1. Pulling out the communication cable or shutting down the software during communicating will fail the communication and lead to the breakdown of the instrument.

2. Please restart the instrument if the communication fails.

The software is programmed with C++. The language is Chinese. The picture below shows the running of the software.

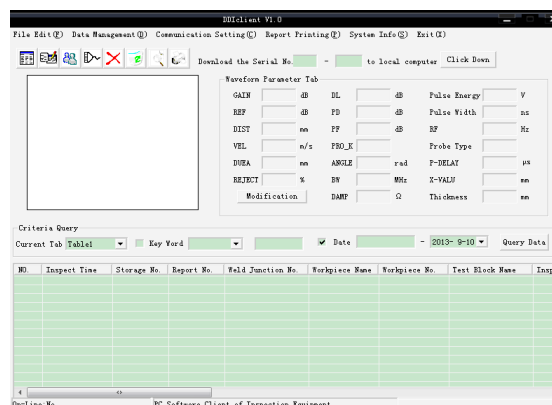

8.2 Main Functions

1. “Download the number from the instrument to the PC”: This function can download the flaw detecting information, graphs and data saved in YUT-2600 to PC.

2. “The current display of data serial number”: This function can control the setting of certain status on YUT-2600 through PC.

3. “Searching conditions”: This function can show the flaw detecting information graphs and data which meet the searching conditions on PC.

4. “Print the flaw detection report”:

a. When connected with YUT-2600, download the flaw detecting information graphs and data saved in the instrument to PC.

b. Select the data information for print in data interface. Click “Print report” menu. Then click the “print preview”.

c. Click the “parameter correction” or “report correction” in print preview if any adjustment is needed. If not, click “print” directly.

d. The format of the general reports output by the YUT-200 is shown as the table below: (Appendix

I) See HELP file DDIClient.chm for more detailed operating steps of the instrument.

Flaw Detection Reports

Number: 2

2007-01-01

Workpiece name: steel plate	Gain: 30.0dB	Fixed amount:0.0dB
Workpiece number: 0001	Compensation: 0.0dB	Evaluated value: 0.0dB
Weld d junction number:	Sound distance:250mm	Waste value: 0.0dB
Workpiece thickness:25mm	Sound speed:5920m/s	PRO_K: 0.02
Probe type: single wafer	Shifting: 0mm	ANGLE: 1.1 rad
Probe Delay:0.00us	Suppression: 0%	Pulse energy: 100v
X-VALU:0.0mm	Band width: 0.4-15MHZ	Pulse width: 200ns
Block name:	Damping: 50	Pulse Repetition Frequency:200hz

Appendix II**Terminology**

This appendix lists the special terms used in ultrasonic nondestructive testing. Knowing the accurate definition of them will help users have a better understanding of this operator's manual.

Flaw: Wrong sizes, shapes, orientations, positions or property which may damage the workpieces or the discontinuity which fails to meet the acceptance criteria.

Horizontal Linearity: A measure of the proportionality of the positive relationship between the signals displayed on the space or distance shaft on the screen of the ultrasonic defectometer and the signals received by the receiver. The received signals can be obtained through the time generator or through the multiple echoes of the panel whose thickness is already known.)

Vertical Linearity: A measure of the proportionality of the positive relationship between the screen time of the ultrasonic defectometer or the signals shown on the distance shaft and the signal amplitude input into the receiver.

Dynamic Range: The ratio between the maximum and minimum reflection area which can be identified on the screen of ultrasonic defectometer.

Pulse Repetition Frequency: the pulse frequencies produced per second when the impulsator drives the probe wafer in order to generate ultrasonic waves.

Inspection frequency/Test frequency: the frequency used when ultrasonic defectometer detecting flaws. The average frequency is 0.4 MHz ~15MHz.

Sensitivity: A measure of the minimum ultrasonic signal which can produce identifiable instructions on the screen of ultrasonic defectometer.

Surplus sensitivity: the difference value between the standard flaw detection sensitivity and the maximum detection sensitivity represented by certain power level in the system of ultrasonic flaw deflection.

Resolving power: The power for the ultrasonic flaw detecting system to differentiate the closest neighboring flaws of certain sizes in the direction of horizon, length and depth.

Suppression: the means to suppress or reduce the signals of low amplitude (the noises of electricity or materials) to amplify the higher signals in the ultrasonic defectometer.

Gating: an electronic method to monitor the flaw detecting signals or to select a time range for further processing.

SCR (signal to clutter ratio): the ratio between the ultrasonic signal amplitude and the biggest background

noise, generally represented by decibel (dB).

Gain: the gaining logarithmic form of the amplifier voltage received by the ultrasonic defectometer, represented by decibel (dB).

DAC: a group of curved lines drawn on the basis of the distance of the known reflector which has produced echoes, the gaining of the instrument and the sizes of the reflector according with the regulated principles.

In practice, the equivalent size can be estimated through the curved lines based on the detected flaw distance and gain value.

Coupling: the function of conveying sound waves between the probe and the tested workpiece.

Test block: the sample used for evaluating the property and flaw detecting sensitivity of the ultrasonic system.

Standard test block: the blocks whose materials, shapes and sizes having been appraised by the authoritative organizations or supervising departments used for testing the ultrasonic testing system or the system performance and adjusting its sensitivity.

Reference block: The blocks made from the similar materials of the tested ones for adjusting the ultrasonic testing system sensitivity or comparing the flaw sizes.

Probe: the device for transforming the electricity and sound which can either emit or receive (or both emit and receive) the ultrasonic energy. It usually consists of trademark, plug, case, back lining, piezoelectric element, protective film or shim block.

Straight probe: the probe used for detecting flaws in a vertical direction, mainly for longitudinal wave flaw detection.

Angle probe: Used for angle flaw detection, mainly for transverse wave flaw detection.